



USER'S MANUAL
MANUEL DE L'UTILISATEUR
MANUAL DEL USUARIO

EW24T3LW

Contents

Safety and warnings.....	2-3
Introduction.....	4
Stand installation guide.....	5
Installation.....	6-9
Remote Control.....	10
Operation.....	11-14

Important Safety Instructions

- 1) Read these instructions.
- 2) Keep these instructions.
- 3) Heed all warnings.
- 4) Follow all instructions.
- 5) Do not use this Television near water.
- 6) Clean only with dry cloth.
- 7) Do not block any ventilation openings, install in accordance with the instructions.
- 8) Do not install near any heat sources such as radiations, heat registers, stoves, or other Television (including amplifiers) that produce heat.
- 9) Do not defeat the safety purpose of the polarized plug. If the provided plug does not fit into your outlet, consult an electrician for replacement of the obsolete outlet.
- 10) Protected the power cord from being walked on or pinched particularly at plugs, convenience receptacles, and the point where they exit from the Television.
- 11) Only use attachments/accessories specified by the manufacturer.
- 12) Unplug this Television during lightning storms or when unused for long periods of time.
- 13) Refer all servicing to qualified service personnel. Servicing is required when the Television has been damaged in any way, such as: power-supply cord or plug is damaged, liquid has been spilled or objects have fallen into the Television, the Television has been exposed to rain or moisture, does not operate normally, or has been dropped.
- 14) Only use attachments/accessories specified provided by the manufacturer, the product is supplied by AC adapter, the AC adapter is used as disconnect device, the disconnect device shall remain readily operable.
- 15) The ventilation should not be impeded by covering the ventilation openings with items, such as newspapers, table-cloth, curtains, etc.
- 16) No naked flame sources, such as lighted candles, should be placed on the Television.
- 17) Attention should be drawn to the environmental aspects of battery disposal.
- 18) The use of Television in moderate climate.

WARNING:

To reduce the risk of fire or electric shock, do not expose this Television to rain or moisture.

WARNING:

The batteries shall not be exposed to excessive heat such as sunshine, fire or the like.

WARNING:

Never place heavy or sharp objects on the LCD panel or frame.



This symbol indicates that this product incorporates double insulation between hazardous mains voltage and user accessible parts. When servicing use only identical replacement parts.



This marking indicates that this product should not be disposed with other household wastes throughout the EU. To prevent possible harm to the environment or human health from uncontrolled waste disposal, recycle it responsibly to promote the sustainable reuse of material resources. To return your used device, please use the return and collection systems or

This Westinghouse product has earned the ENERGY STAR® for meeting U.S. Federal energy efficiency guidelines as set by the Department of Energy and Environmental Protection agency. The ENERGY STAR® program exists to provide energy saving guidelines and help promote energy efficient products and practices. Changes to certain features, settings and functions of this TV can change and/or increase its power consumption. Depending on how settings are changed, power consumption may exceed the limits required for ENERGY STAR® qualification. This Westinghouse TV will operate at optimal energy efficiency in "Home" mode.

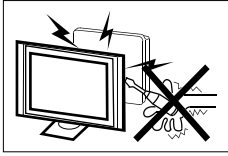

High voltages are used in the operation of this television receiver. Do not open the cabinet. Refer servicing to qualified service personnel.

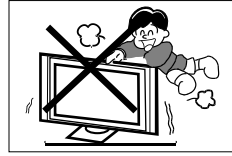

Never stand on, lean on, or suddenly push the television or its stand. You should pay special attention to children. Serious injury may result if it falls.

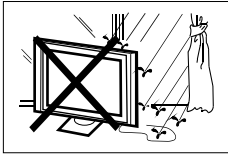

To prevent fire or electrical shock hazard, do not expose the television receiver to rain or moisture.

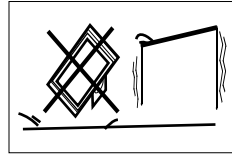

Do not place your television on an unstable cart, stand, shelf or table. Serious injury to an individual and/or damage to the television may result if it falls.

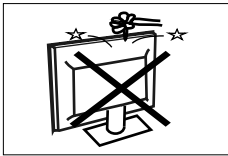

Do not drop or push objects into the television cabinet slots or openings. Never spill any kind of liquid on the television receiver.

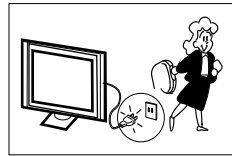

When the television receiver is not used for an extended period of time, it is advisable to disconnect the AC power cord from the AC outlet.



Do not block the ventilation holes on the back cover of the TV. Adequate ventilation is essential to prevent failure of electrical components.

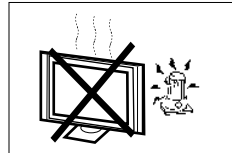

Avoid exposing the television receiver to direct sunlight and other sources of heat. Do not stand the television receiver directly on other products which give off heat, e.g. video cassette players and audio amplifiers. Do not place naked flame sources, such as lighted candles on or near the television.

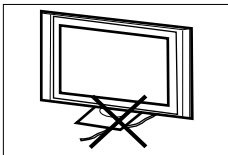

Do not trap the power supply cord under the television receiver's stand.

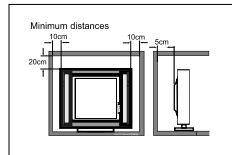

If the television is to be built into a compartment or similar enclosure, the minimum distances must be maintained. Heat build-up can reduce the life of your television, and can also be dangerous.

Main features

Integrated ATSC TV tuner for HDTV broadcast reception
 High brightness provides a vivid and brilliant picture
 Deeper blacks and brighter whites with high contrast
 Wide Screen aspect ratio (16:9) for a complete home theater experience
 HDMI input for true digital connection
 VGA port for connection to PC
 Built-in stereo speaker system
 Full-function Remote Control

Accessories

Power cable..... 1
 Infrared Remote Control..... 1
 User § Manual 1
 Battery(AAA)..... 2

Main parameter

Viewing Picture Size (diagonal)	24 inches
Resolution:	1920 x 1080
Power supply	AC 100-240V 50/60Hz
Power consumption	40W
Audio Output Power (THD ≤ 7%):	2x3W
Aspect Ratio:	16:9
TV System:	ATSC Digital system and NTSC Analog system
Video Signal System:	NTSC
Receiving Channel:	Cable :1-135/ Air: 2-69 (ATV&DTV)
High-Definition Multimedia Interface (HDMI) Input	x 2
YCb(Pb)Cr(Pr) Input	x 1
Composite Video Input	x 1
Analog RGB (VGA) Input	x 1
Audio Input	x 2
Headphone Output	x 1
Coaxial Output	x 1
Horizontal definition (TV line)	Composite Video Input ≥350 Video Input ≥400 YCb(Pb)Cr(Pr) ≥400

Base Stand Assembly Instruction

1. Place the TV with the display side down on a flat surface. Use a cloth to protect the display. Position the stand base plate onto the bottom of the stand pole.

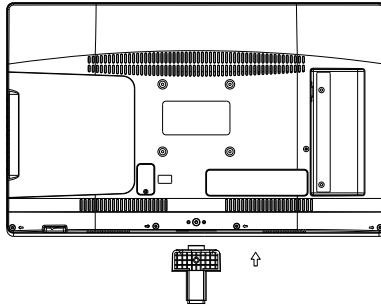

2. Attach the stand base plate to the stand pole by firmly tightening the supplied screw.

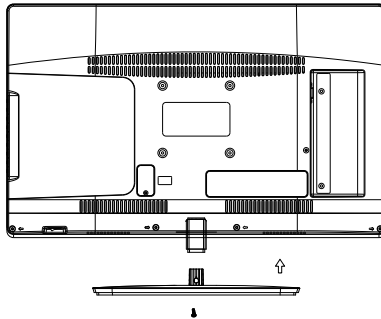

Front panel

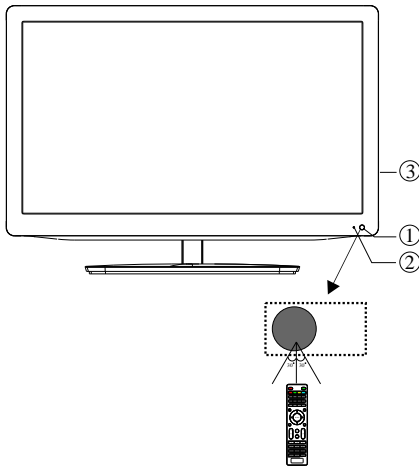

- 1: Remote control sensor.
- 2: Indicator LED: BLUE ● POWER ON.
RED ● STANDBY.
- 3: Side panel keys

Side panel

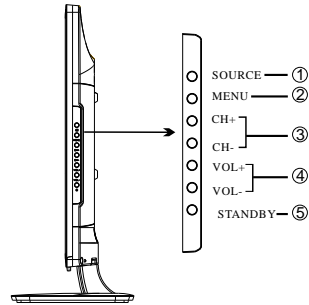

- 1. **SOURCE:** Display the input source menu.
- 2. **MENU:** Display main MENU.
- 3. **CH+/CH-:** In TV mode, press "CH+" or "CH-" to change the channel up and down. In MENU mode, press "CH+" or "CH-" to select items in standby mode, press "CH+" or "CH-" to turn on the TV.
- 4. **VOL+/VOL-:** Adjust sound level. In MENU mode, press "VOL+" or "VOL-" to adjust the item that you selected.
- 5. **STANDBY:** Press this button to turn the unit ON from STANDBY mode. Press it again to turn the set back to STANDBY.

REAR Connections

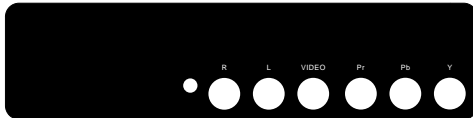

All the terminals are (from left to right):
AUDIO INPUT, VIDEO, YPbPr INPUT

Note: AV and YPbPr share one audio channel.

SIDE Connections



All the terminals are (from left to right):
HDMI1, HDMI2, USB, VGA, HEADPHONE, PC AUDIO, COAXIAL, RF.

- Note: 1. When HDMI1 has an input signal coming from a DVI source then the audio input signal must be connected to the PC audio input.
2. When HDMI2 has an input signal coming from a DVI source then the audio input signal must be connected to the YPbPr/AV audio input.
3. The USB port just used for upgrading

ANTENNA

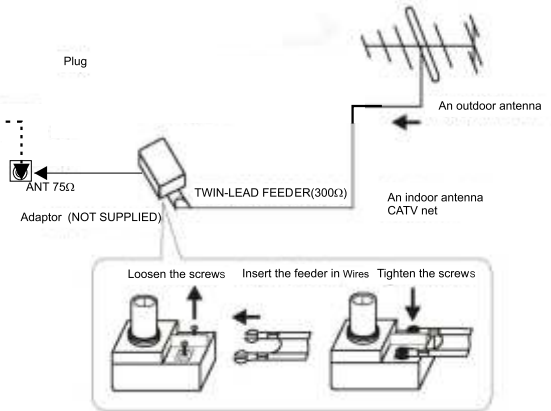
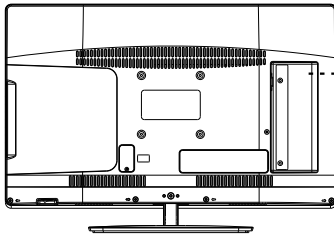

Note:
 Aerial connections: IEC (female).
 Input impedance: 75Ω unbalanced.

PC

STEPS:

Be sure both the TV and computer are set to Power off.

1. Connect VGA and audio cable.
2. Connect the power cord.
3. Power on the TV, switch to PC mode.
4. Power on the PC.

This sequence is very important.

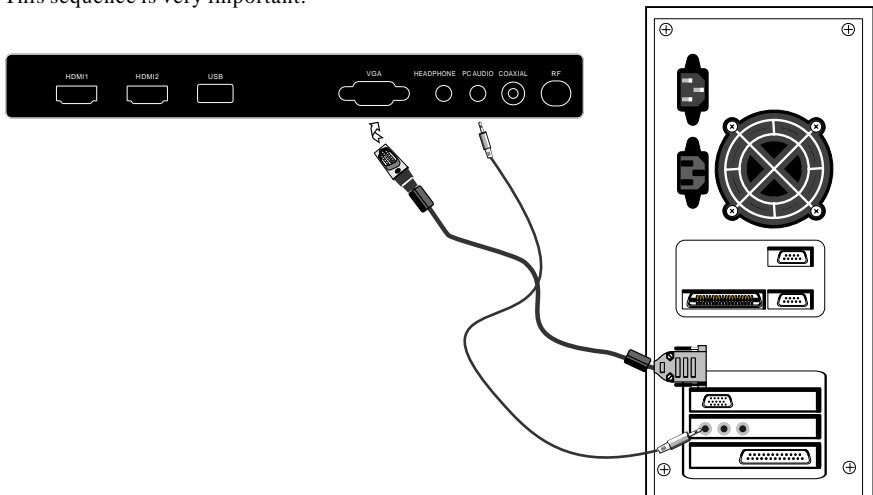

Apply power to the TV by connecting the included AC adaptor to the power input on the back of the set. Make sure when plugging the adaptor into an AC receptacle that the polarized plug is properly inserted. Do not attempt to file or cut the blade.

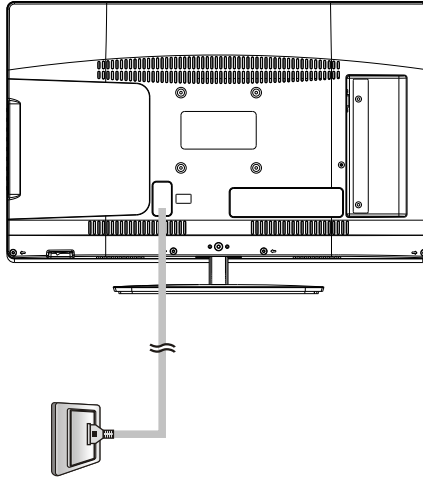
**PC****PRESET MODE**

	RESOLUTION	V.Freq.(Hz)	H.Freq.(KHz)
1	720*400	70	31.47
2	640*480	60	31.47
3	640*480	75	37.50
4	800*600	60	37.88
5	800*600	75	46.88
6	1024*768	60	48.36
7	1024*768	70	56.48
8	1024*768	75	60.02
9	1280*1024	60	63.98
10	1280*1024	75	80.00
11	1920*1080	75	80.00

AV EQUIPMENT

You can use the input terminals on TV set rear as follows.

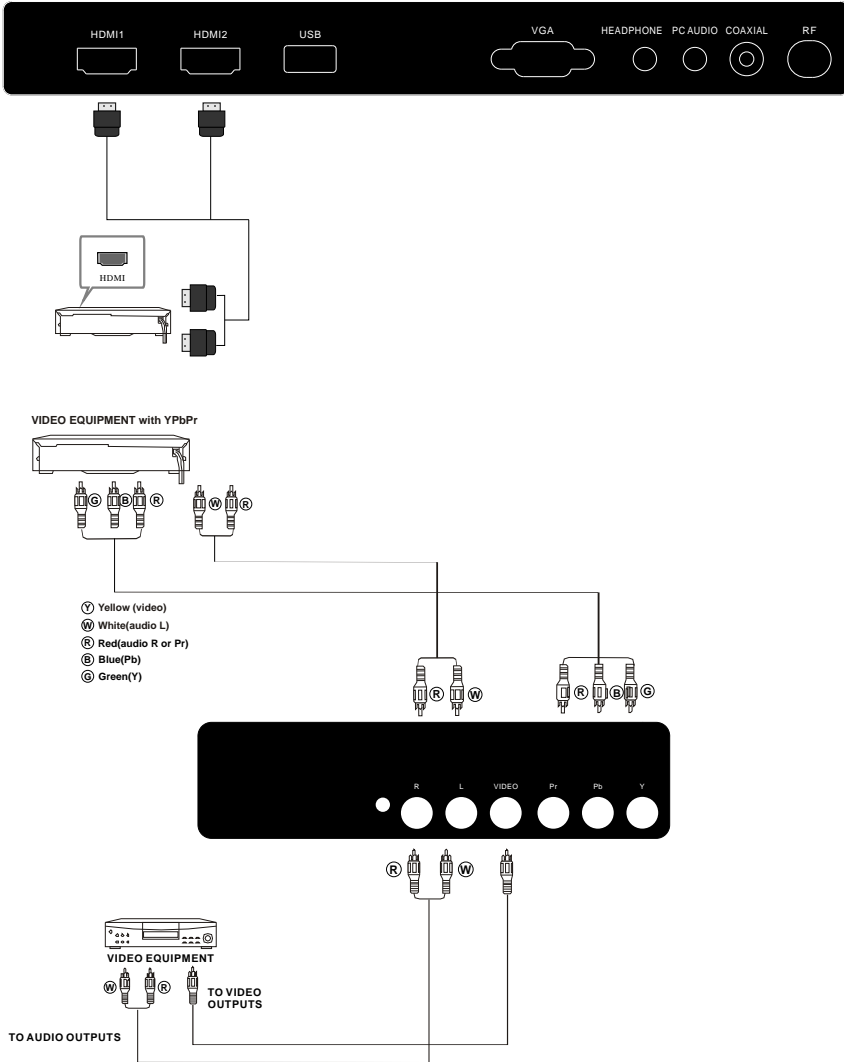

The television's inputs can be connected to the following types of equipment: VCR, multi disc player, DVD, camcorder, video game or stereo system, etc.....
 YPbPr can support these video formats:480i,576i,480p,576p,720p,1080i.

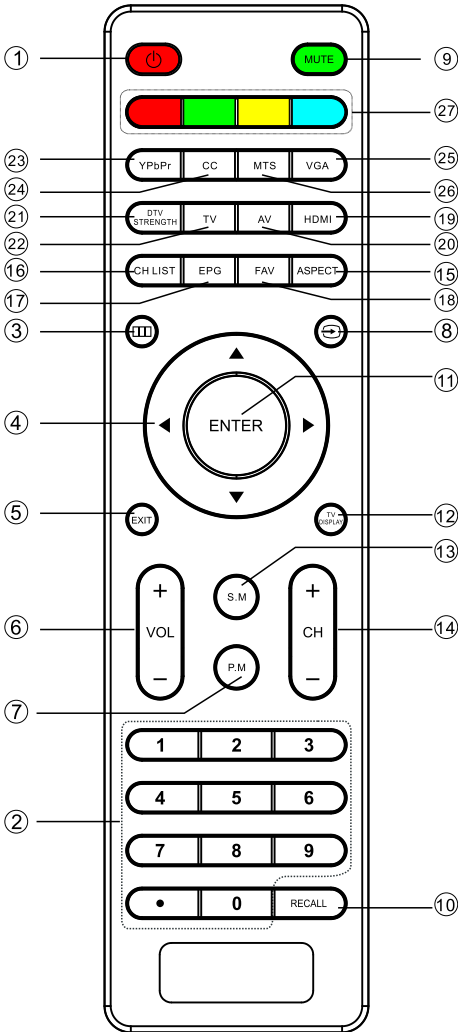

- 1: **POWER**
To turn the TV on.
- 2: **NUMBER KEY**
For direct access to channels.
- 3: **□□□**
Displays the main on-screen menu.
- 4: **CURSOR**
To move within the menu.
- 5: **EXIT**
To exit the menu.
- 6: **VOL+/-**
To adjust sound level.
- 7: **P.M**
To switch picture mode.
- 8: **↔**
Press to display and select the available video sources.
- 9: **MUTE**
To disable or enable the sound.
- 10: **RECALL**
To access the previously viewed channel.
- 11: **ENTER**
Confirms selection.
- 12: **TV DISPLAY**
Displays/removes the program information
- 13: **S.M**
To switch sound mode.
- 14: **CH+/CH-**
To access the next or previous channel.
- 15: **ASPECT**
To change picture aspect .
- 16: **CH LIST**
To display the channel list.
- 17: **EPG**
To display all the information of DTV programs.
- 18: **FAV**
To access your favorite channels in digital TV mode.
- 19: **HDMI**
Hot key to go directly to HDMI source.
- 20: **AV**
Hot key to go directly to AV source.
- 21: **DTV STRENGTH**
To display the DTV signal strength menu.
- 22: **TV**
Hot key to go directly to TV source.
- 23: **YPbPr**
Hot key to go directly to YPbPr source.
- 24: **CC**
To enable or disable the CC function.
- 25: **VGA**
Hot key to go directly to VGA source.
- 26: **MTS**
To switch the sound stereo.
- 27: **COLOR KEYS**
Reserved keys

1. PICTURE MENU

The first item of the MENU is PICTURE MENU. You can adjust picture effect here, such as contrast, brightness, etc. Press ▼▲ to select, press ◀▶ to adjust, press MENU to exit.

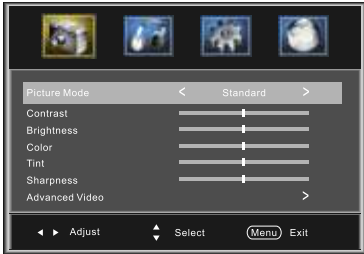

Note:
If you want to adjust contrast, brightness, color, and sharpness, the picture mode must return to "Custom" status.

Advanced Video:

Press ▼▲ button to select Advanced Video, press ▶ button, the screen will display as follow:



2.AUDIO menu

The second item of the MENU is AUDIO MENU. You can adjust sound here. Press ▼▲ to select, press ◀▶ to adjust, press MENU to exit.

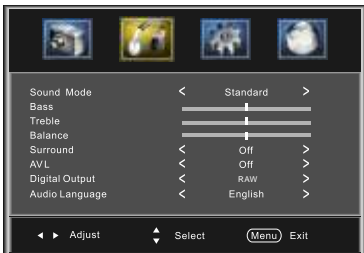

Note:
Audio language is available in ATSC/TV Programming only.

3. SETUP MENU

The third item of the MENU is SETUP MENU. You can setup system here. Press ▼▲ to select, press ◀▶ to adjust, press MENU to exit.

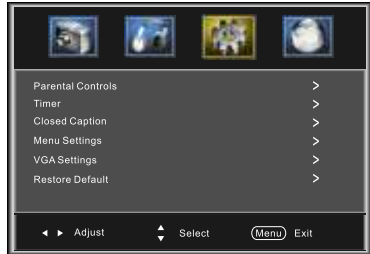

Note:
Restore Default: Reset all the settings to default value.

3.1. Parental Controls:

Press ▼▲ button to select Parental Controls, Press ▶ button, the screen will display as follow:

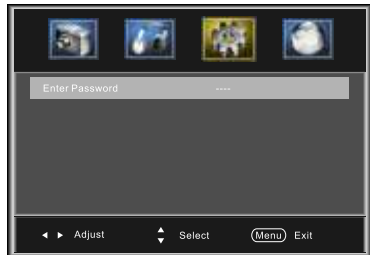

Enter the password, it will go into Parental Control menu. Factory default password is 6666.

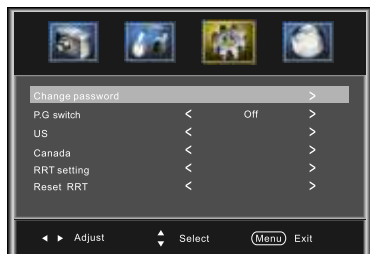

Change Password:

Press ► button, the screen will display as follow:

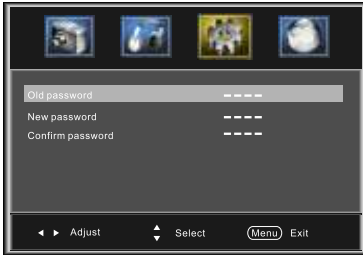

- 1).Old password: Input the old password
- 2).New password: Input the new password
- 3).Confirm password: Input the new password again

P.G Switching:

When the Parental Control switch is ON, the below options listed below can beadjusted.

US: Press ► button, the screen will display as follow:

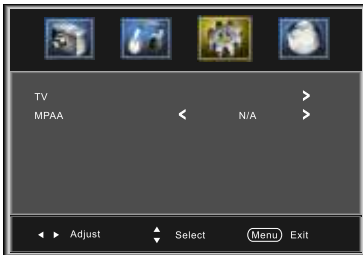

- 1):TV: Press ►button, the screen will display as follows:

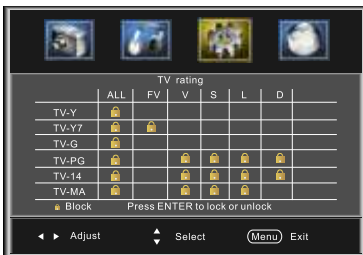

Rating	Content	Content				
		FV (Fantasy violence)	V (Violence)	S (Sexual situation)	L (Adult language)	D (Sexually suggestive dialog)
Suggested age	TV-Y (All children)					
	TV-Y7(Direct to order children)	X				
	TV-G(General audience)					
	TV-PG(Parental Guidance suggested)		X	X	X	X
	TV-14(Parents strongly cautioned)		X	X	X	X
TV-MA(Mature audience only)		X	X	X		

And use the ENTER key to switch lock/ unlock Parental Control feature.

- 2).MPAA: Switching the movie-rating control level; N/A, G, PG, PG-13, R, NC-17, X.

Rating	Description
G	General audiences, All Ages admitted
PG	Parental Guidance suggested. Some material may not be Suitable for children.
PG-13	Parents strongly cautioned. Some material .may be Inappropriate for children under 13.
R	Restrict. Under 17 requires accompanying parent or adult guardian(age varies in some jurisdictions)
NC-17	No one 17 and under admitted.
X	X is an order rating that is unified with NC-17 but may be encoded in the data of order movies.

Canada: Press ► button, the screen will be displayed as follow:

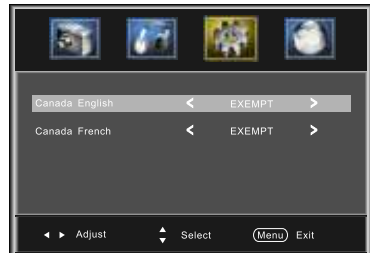

- 1): Canada English: Switching the English rating control level: EXEMPT, C, C8+, G, PG, 14+, 18+.

Rating	Description
E	Exempt: Includes news, sports, documents and other information programming; talk shows, music videos, and variety programming.
C	Children: Intended for younger children under the age of 8 years. Pays careful attention to themes that could threaten their sense of security and well-being.
C8+	Children over 8 years old: Contains no portrayal of violence as the preferred, acceptable, or only way to resolve conflict; nor encourage children to imitate dangerous acts which they may see on the screen.
G	General: Considered acceptable for all age groups, Appropriate viewing for the entire family, contains very little violence, physical, verbal or emotional.
PG	Parental Guidance: Intended for a general audience, but may not be suitable for younger children (under the age of 8) because it could contain controversial themes or issues.
14+	Over 14 Years: Could contain themes where violence is one of the dominant elements of the storyline But it must be integral to the development of plot or character. Language usage could be profane and nudity . present within the context of theme.
18+	Adults: Intended for viewers 18 years and older and might contain depictions of violence, which while related to the development of plot, character or themes, are intended for adult viewing. Could contain graphic language and portrayals of secretary and nudity.

2).Canada French: Switching the French-rating control level: E, G, 8ANS+, 13 ANS+, 16ANS+, 18ANS+.

Rating	Description
E	Exempt programming
G	General :All ages and children, contains minimal direct violence, but may be integrated into the plot in a humorous or unrealistic manner .
8ans+	General but inadvisable for young children :May be viewed by a wide public audience, but could contain scenes disturbing to children under 8 who cannot distinguish between imaginary and real situations. Recommended for viewing with paren.
13ans+	Over 13 years: Could contain scenes of frequent violent scenes and in tense violence.
16ans+	Over 16 years: Could contain frequent violent scenes and violence.
18ans+	Over 18 years: Only for adult viewing. Could contain frequent violent scenes and extreme violence.

RRT setting: in ATSC digital TV mode, it can be adjusted

Reset RRT: Press **▶** button, the screen will be displayed as follow:



3.2 Timer

You can adjust the timer here.

Press **▼▲** to select, press **◀▶** to adjust, press MENU to exit.



Sleep Timer: Adjust this item to set the sleep timer. Note:

Time zone, DST and the clock are available in ATSC programming only, and the Clock can't be adjust.

3.3 Closed Caption: Switching close caption mode.

Press **▼▲** button to select Closed Caption, Press **▶** button, the screen will display as follow:

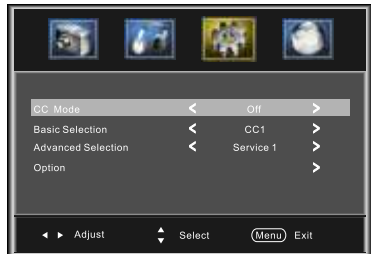

1):Advanced selection: only ATSC program is available.

2):Option: Used to edit CC font.

Press **▶** button, the screen will display as follow:

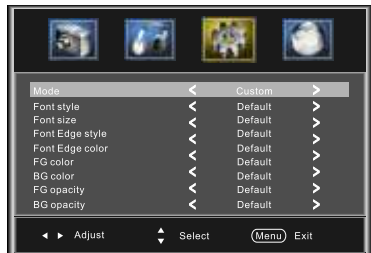

NOTE: Only ATSC program is available.

3.4 Menu Settings

You can adjust the Menu Settings here. Press ▼▲ to select, press ◀▶ to adjust, press MENU to exit.



3.5 VGA Settings: When PC Mode is available.

Press ▼▲ button to select VGA Settings, Press ▶ button, the screen will display as follow:

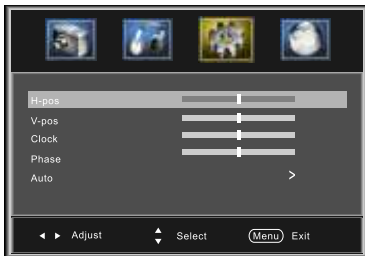

- 1).H-Pos: Adjust the horizontal position of the screen.
- 2).V-Pos: Adjust the vertical position of the screen.
- 3).Clock: Fine tune the screen width.
- 4).Phase: Fine tune the phase of the screen. Usually don't adjust this item.
- 5).Auto: Auto adjust to fit the screen.

4. Channel MENU

The fourth item of the MENU is Channel MENU. You can adjust digital and analog TV Channels. Press ▼▲ to select, press ▶ to adjust.

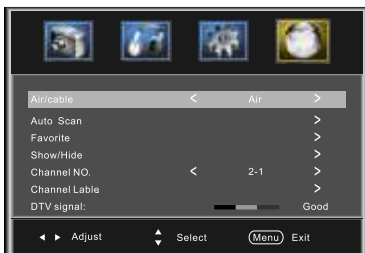

- 1). Air/Cable: select Air TV signal and cable TV signal.
- 2). Auto Scan: If it's the first time you use the TV, you should scan all the TV channels first, press the ▶ button to confirm, you will see the menu:



select " yes " item and press the ENTER button to confirm, You will see the message below which indicates auto search is in process.

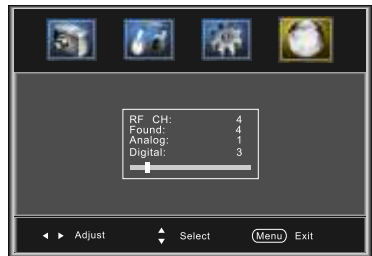

- 3). Favorite: Press ◀▶ button to choose/delete the favorite channel.
- 4). Show/Hide: Press ◀▶ button to display or hide current channel.
- 5). Channel NO. :Display the current channel number.
- 6). Channel label: Press ▲▼button to edit current channel name.
- 7). DTV signal: Display DTV strength signal. It can't be selected and adjusted.



www.westinghousedigital.com



S/N: _____



Westinghouse Digital, LLC
Orange, CA

SE-UM-2401-1201